

men4tec – Engineering services since 2001

On the following slides, we would like to present the activities of men4tec in the area of product and concept development.

Our employees and freelancers will support you competently and efficiently in your planned project period.

The collaboration can take place:

- on hourly basis wage,
- as a work or project contract at a fixed price,
- in the form of a consultation
- or as a temporary employment.



Matthias Meyer, CEO

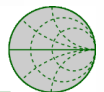

Our offer

- Engineering services for telecommunications and information technology
- Mobile Infotainment
- Solutions for embedded software
- Testing, validation and verification
- Feasibility analysis
- Prototype manufacturing

Hardware know-how

- Circuit design and layout
- Antenna development
- Simulation
- Radio engineering
- EMV, EMC tests, circuit optimization
- Technical specification and documentation
- Feasibility analysis, concept development
- Multimedia systems und HMI systems

Simulation und programming

- RF simulation with
 - PSPICE, Micro-Cap
 - ADS
 - Ansoft
- Circuit design with
 - EAGLE
 - Zuken Tools
 - Protel, Altium
- 3D EM simulation
 - CST MICROWAVE STUDIO
 - FEKO
- SW programming with
 - C, C++, C#
 - Visual Basic, Visual C
 - LabVIEW
 - VHDL
 - MATLAB, Simulink

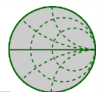

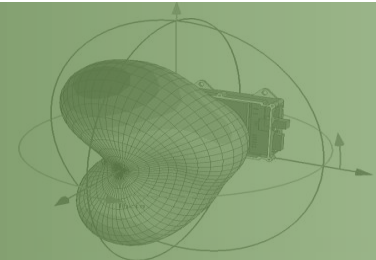

Simulation

Antenna design and simulation with CST MICROWAVE STUDIO

- GSM, LTE, GPS, AM, FM, TV
- SDARS
- RFID
- RADAR
- SM-Band
- WLAN
- Bluetooth

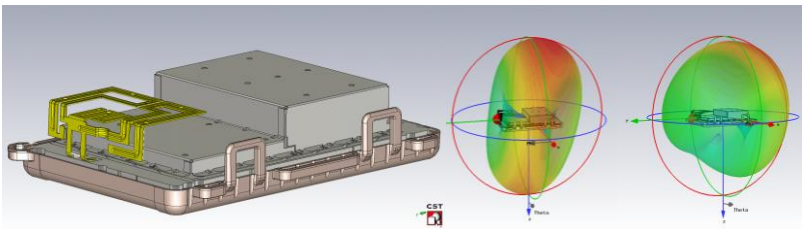
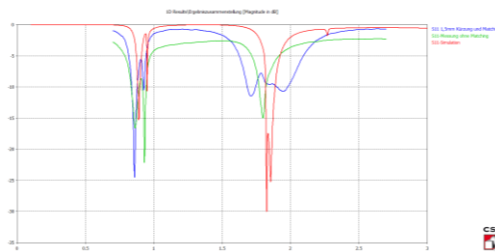

Circuit design and simulation with SPICE

- Power management
- Analog audio
- Analog video
- Switching

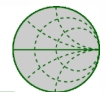
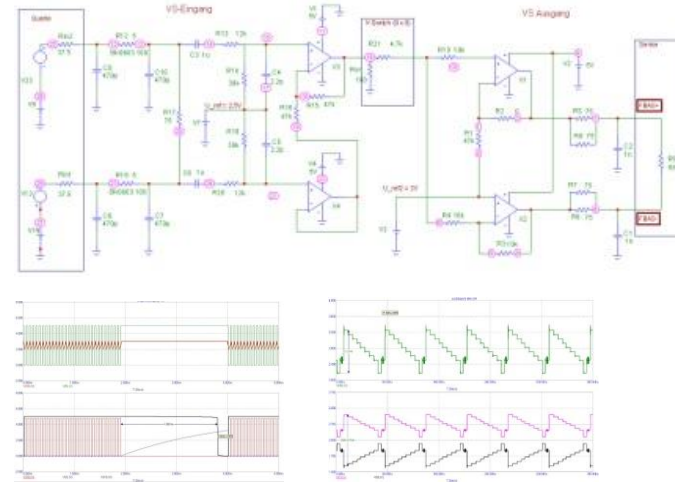

Telecommunications and information technology

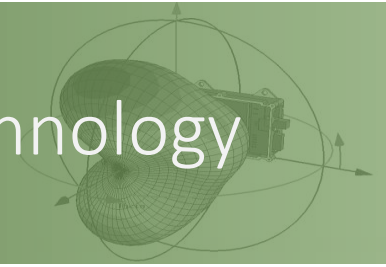

- Low level amplifier from 1 to 5000 MHz
- Microcontroller and interfaces
- Digital signal processing and modulation
- WLAN, Bluetooth, WiMAX, RFID
- Radio Solutions
- Graphics and display solutions

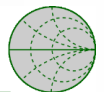
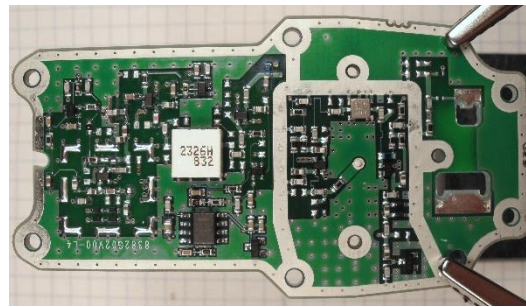
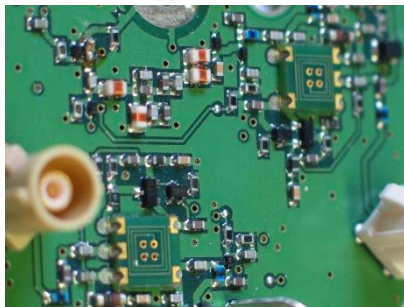

Measuring station control and measurement data processing



- LabVIEW
- MATLAB, Simulink
- Visual Basic
among others

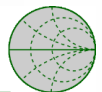
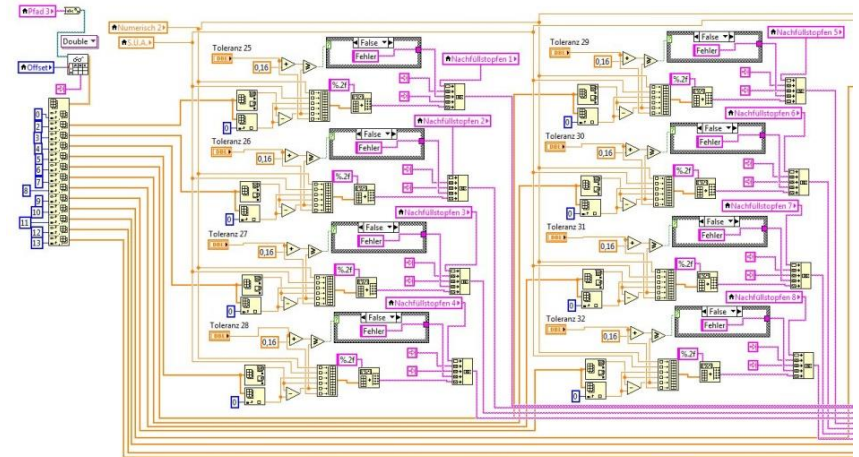
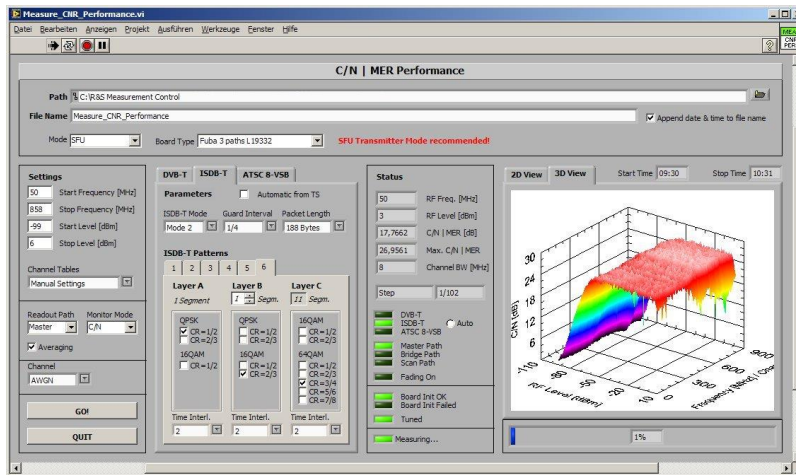



For further questions we are always at your disposal.



info@men4tec.de



www.men4tec.de



05139 9509422



01577 8900003



Schulstr.30
30938 Burgwedel/ Wettmar

our know-how is your key

men4tec

